

REVISIONS			DATE	APPROVED
ZONE	REV	DESCRIPTION		

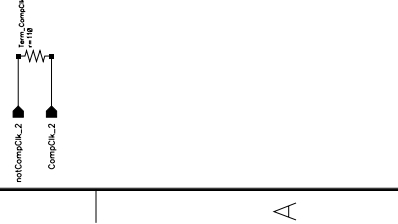
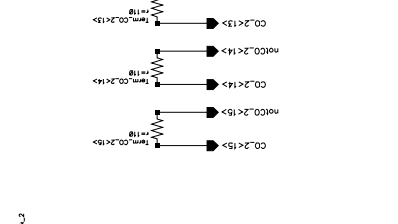
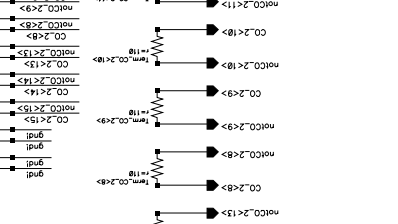
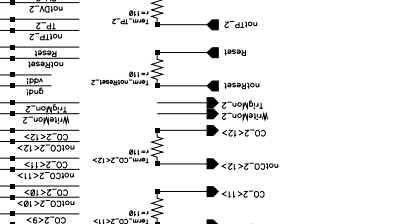
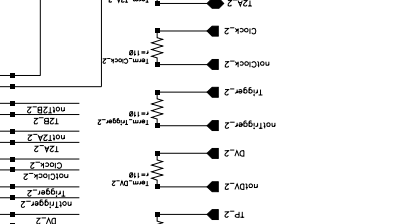
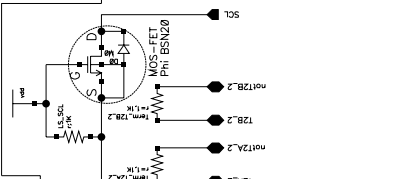
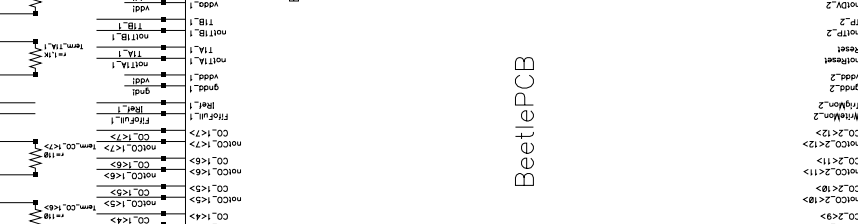
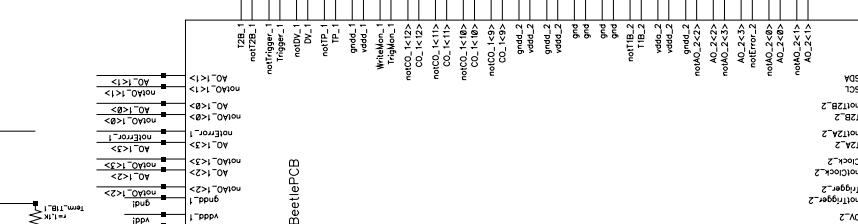
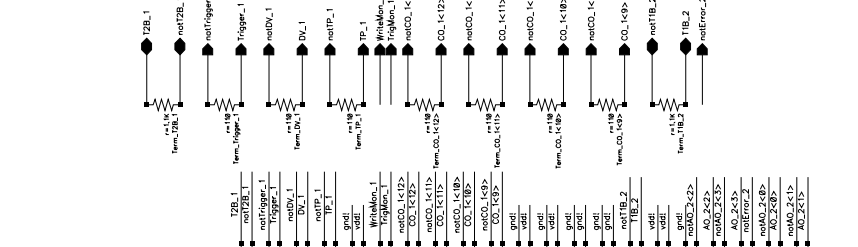
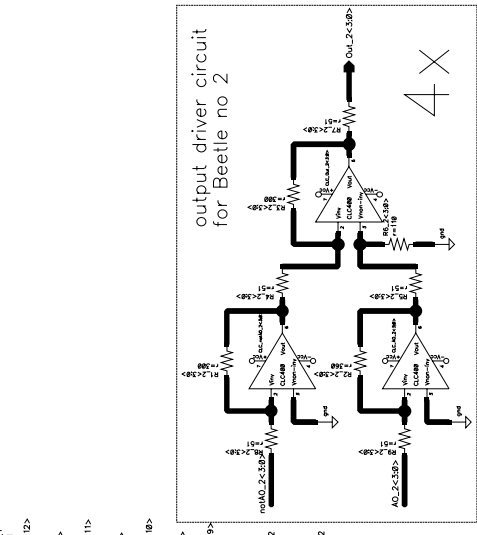
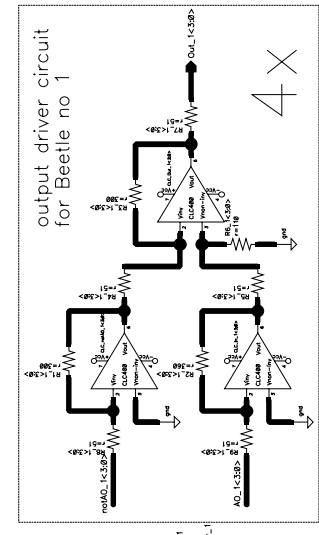

UPDATED
Jan 25 19:04:10 2002

DRAWN Sven Loechner

CHECKED

ISSUED

SCALE

SHEET OF

Ver 1.0

ASIC Lab. Heidelberg

motherboard

Beetle 1.1

CAGE NO.	DWG NO.
REV	SH